

293/530

Dimensions

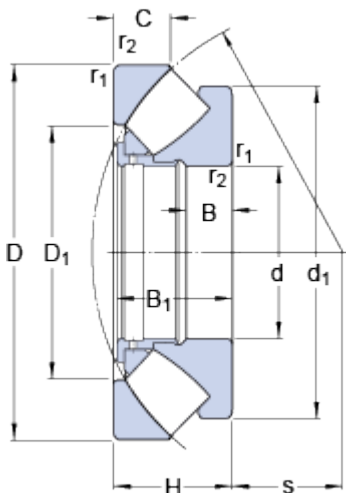

d	530	mm
D	800	mm
H	160	mm
d ₁	≈ 741	mm
D ₁	≈ 641	mm
B	55	mm
B ₁	154	mm
C	81	mm
s	295	mm
r _{1,2}	min. 7.5	mm

Abutment dimensions

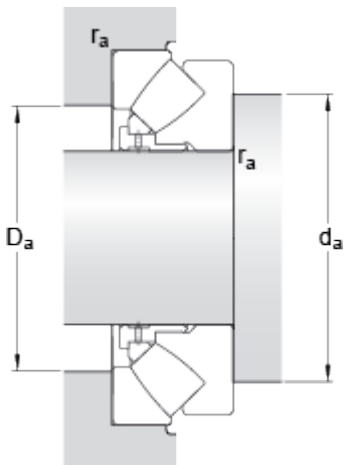

d _a	min. 665	mm
D _a	max. 715	mm
r _a	max. 6	mm

Calculation data

Basic dynamic load rating	C	5870	kN
Basic static load rating	C ₀	26500	kN
Fatigue load limit	P _u	2080	kN
Reference speed		400	r/min
Limiting speed		750	r/min
Minimum axial load factor	A	67	

Mass

Mass bearing		265	kg
--------------	--	-----	----